

MGS · MGSD · MGSDD · MGST

.100 GRID HIGH-PERFORMANCE RELAYS

MGS

**SENSITIVE .100 GRID
HIGH-PERFORMANCE RELAY**

**QUALIFIED TO
MIL-R-39016/41**

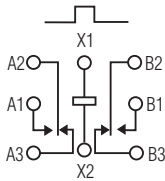

TERMINAL VIEW

FEATURES

- Hermetically sealed
- High shock & vibration ratings
- Mounting pads
- Excellent RF switching

MGSD

**SENSITIVE .100 GRID
DIODE SUPPRESSED
HIGH-PERFORMANCE RELAY**

**QUALIFIED TO
MIL-R-39016/42**

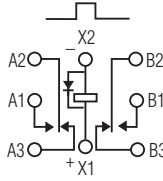

TERMINAL VIEW

FEATURES

- Suppression diode
- Hermetically sealed
- High shock & vibration ratings
- Mounting pads
- Excellent RF switching

MGSDD

**SENSITIVE .100 GRID DIODE
SUPPRESSED/PROTECTED
HIGH-PERFORMANCE RELAY**

**QUALIFIED TO
MIL-R-39016/43**

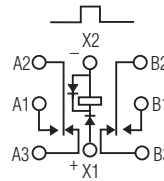

TERMINAL VIEW

FEATURES

- Suppression & protection diodes
- Hermetically sealed
- High shock & vibration ratings
- Mounting pads
- Excellent RF switching

MGST

**SENSITIVE .100 GRID DIODE
SUPPRESSED/MOSFET
DRIVEN HIGH-PERFORMANCE
RELAY**

**QUALIFIED TO
MIL-R-28776/7**

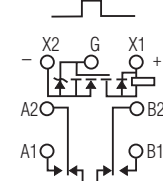

TERMINAL VIEW

FEATURES

- MOSFET driver, zener & suppression diodes
- Hermetically sealed
- High shock & vibration ratings
- Mounting pads
- Excellent RF switching

ELECTRICAL CHARACTERISTICS

CONTACT ARRANGEMENT

2 Form C (DPDT)

CONTACT MATERIAL

Stationary:
Gold/platinum/palladium/silver
(gold plated)

Moveable:

Gold/platinum/palladium/silver
(gold plated)

CONTACT RESISTANCE

Before Life: 100 milliohms max.
(measured @ 10 mA @ 6 Vdc)

After Life: 200 milliohms max.
(measured @ 1 A @ 28 Vdc)

MECHANICAL LIFE EXPECTANCY

1 million operations

COIL VOLTAGE

5 to 48 Vdc

COIL POWER

565 mW max. @ 25°C

DUTY CYCLE

Continuous

PICK-UP VOLTAGE

Approximately 50% of
nominal coil voltage

PICK-UP SENSITIVITY

60 mW max. @ 25°C

CONTACT RATINGS

CONTACT LOAD	TYPE	OPERATIONS MIN.
1.0 A @ 28 Vdc	Resistive	100,000
250 mA @ 115 Vac, 60 Hz & 400 Hz	Resistive (case not grounded)	100,000
100 mA @ 115 Vac, 60 Hz & 400 Hz	Resistive	100,000
0.2 A @ 28 Vdc	Inductive (0.32 Henry)	100,000
0.1 A @ 28 Vdc	Lamp	100,000
30 µA @ 50 mVdc	Low Level	1,000,000
0.1 A @ 28 Vdc	Intermediate Current	50,000



MGS

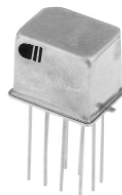

MGST

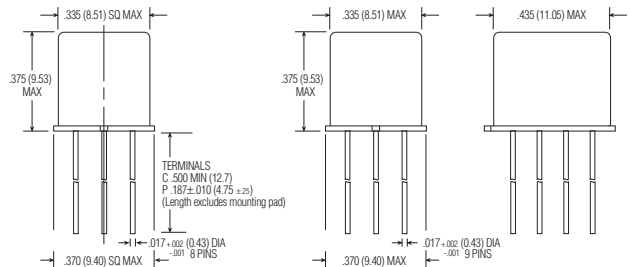

MGS/MGSD/MGSDD ENCLOSURE

MGST ENCLOSURE

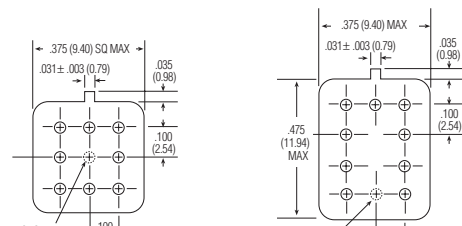

MGS/MGSD/MGSDD HEADER

MGST HEADER

OPERATING CHARACTERISTICS

TIMING

Operate Time:
4.0 ms max.

Release Time:
MGS: 2.0 ms max.
MGSD/MGSDD: 7.5 ms max.
(suppression diode, protection/suppression diodes)
MGST: 7.5 ms max.
(suppression/zener diodes)

CONTACT BOUNCE

1.5 ms max.

DIELECTRIC WITHSTANDING VOLTAGE

Between Open Contacts:
500 Vrms 60 Hz

Between Adjacent Contacts:
500 Vrms 60 Hz

Between Contacts & Coil:
500 Vrms 60 Hz

INSULATION RESISTANCE

10,000 megohms min. @ 500 Vdc
1,000 megohms @ 500 Vdc
(coil to case @ +125°C)

ENVIRONMENTAL CHARACTERISTICS

TEMPERATURE RANGE

-65°C to +125°C

WEIGHT

0.09 oz. (2.55 gms)
0.129 oz. (3.45 gms) w/ mounting pad attached

VIBRATION RESISTANCE

30 G's, 10 to 3,000 Hz

SHOCK RESISTANCE

75 G's, 6 ±1 ms max.

QPL APPROVAL

MIL-R-39016/41 (JMGS)
MIL-R-39016/42 (JMGSDD)
MIL-R-39016/43 (JMGSDD)
MIL-R-28776/7 (JMGSST)

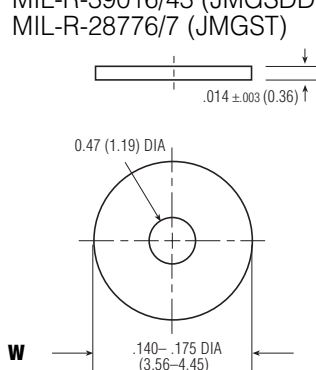

MGS/MGSD/MGSDD MOUNTING PAD

SEMICONDUCTOR CHARACTERISTICS

DIODE

100 Vdc peak inverse voltage (PIV)
1.0 Vdc max. transient voltage

ZENER DIODE

20 Vdc ±3 Vdc over temperature range

MOSFET

0.5 Vdc min. gate turn off voltage
4.3 Vdc max. gate turn on voltage

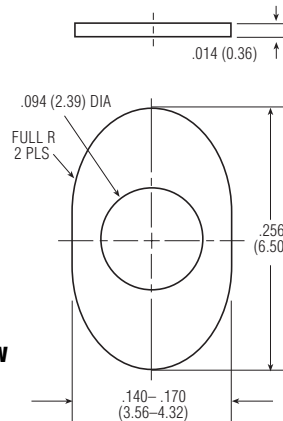

MGST MOUNTING PAD

COIL DATA

NOM. COIL VOLTAGE (Vdc)	COIL RESISTANCE IN OHMS ±10% @ 25°C (Note)	COIL CIRCUIT CURRENT mA (MAX.) (Note)	COIL CIRCUIT CURRENT mA (MIN.) (Note)	PICKUP VOLTAGE Vdc (MAX.) @ 25°C	PICKUP VOLTAGE Vdc (MAX.) @ 125°C	DROP-OUT VOLTAGE Vdc (MIN.) @ 25°C	DROP-OUT VOLTAGE Vdc (MIN.) @ -65°C	NOM. COIL POWER (mW) @ 25°C	MAX. COIL VOLTAGE	COIL DESIG.
MGS/MGSD										
5.0	100	n/a	n/a	2.6	3.5	0.23	0.12	250	7.5	5
6.0	200	n/a	n/a	3.4	4.5	0.28	0.18	180	10.0	6
9.0	400	n/a	n/a	4.85	6.8	0.55	0.35	203	15.0	9
12.0	800	n/a	n/a	7.0	9.0	0.64	0.41	180	20.0	12
18.0	1,600	n/a	n/a	9.8	13.5	0.92	0.59	203	30.0	18
26.5	3,200	n/a	n/a	14.0	18.0	1.4	0.89	219	40.0	26
36.0	6,500	n/a	n/a	20.0	27.0	1.8	1.25	199	57.0	36
48.0	11,000	n/a	n/a	25.8	36.0	2.4	1.60	209	75.0	48
MGSDD										
5.0	64	78.1	56.8	2.9	3.7	0.8	0.7	391	7.5	5
6.0	125	48.9	36.3	4.0	4.8	0.9	0.8	288	10.0	6
9.0	400	23.6	18.1	6.1	8.0	1.1	0.9	203	15.0	9
12.0	800	16.0	12.5	7.8	11.0	1.3	1.0	180	20.0	12
18.0	1,600	12.2	9.6	11.3	14.5	1.5	1.1	203	30.0	18
26.5	3,200	9.0	7.2	15.2	19.0	1.7	1.3	219	40.0	26
36.0	6,500	6.1	4.9	21.7	27.2	2.3	1.7	199	57.0	36
48.0	11,000	4.8	3.9	27.8	34.8	2.8	2.0	209	75.0	48
MGST										
5.0	100	56.0	43.0	2.9	4.0	0.23	0.13	250	5.6	5
6.0	200	33.0	27.0	3.5	4.9	0.32	0.18	180	8.0	6
9.0	400	26.4	17.8	5.3	7.3	0.48	0.27	203	12.0	9
12.0	800	17.7	11.3	7.1	9.8	0.65	0.36	180	16.0	12
18.0	1,600	13.8	8.4	10.6	14.6	0.97	0.54	203	24.0	18
26.5	3,200	10.2	5.8	14.2	19.5	1.30	0.72	219	32.0	26

Note: Coil resistance not directly measurable. Coil current should be within limits shown when tested at nominal voltage at 25°C for 5 seconds max.

SPECIFYING A PART NUMBER EXAMPLE: TYPE MGS TERMINALS C DIODES TRANSISTOR D GROUND PINS G COILS -26 MOUNTING PADS W

